



LED LIGHTING SYSTEM



Owner's Manual

Manuali dei Prodotti

用戶手冊

Bedienungsanleitung

Manual do Proprietário

使用說明書

Mode d'emploi

Instrukcja Obsługi

Dear Customer,

Thank you for purchasing this product.

For optimum performance and safety, please read these instructions carefully.

English

User Memo:

Date of purchase: _____

Dealer name: _____

Dealer address: _____

Dealer website: _____

Dealer email: _____

Dealer phone no.: _____

Please visit us on facebook or twitter!



<https://www.facebook.com/Maxspect>



<http://twitter.com/maxspectled>

Package Content

Please check the content in the package.

English

R5-100

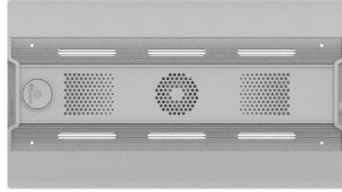

R5-150

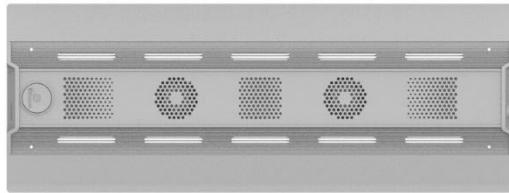

R5-200

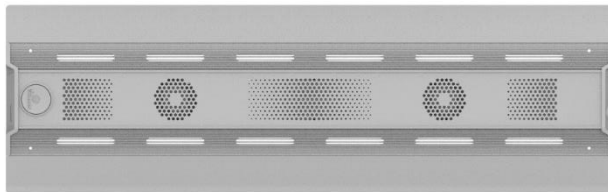

R5-300



Power Supply Unit

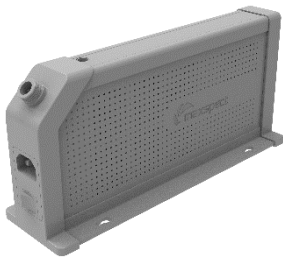

Power Cable



PVC Sticker



Stands



ThumbScrews

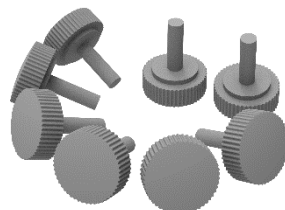

Screws

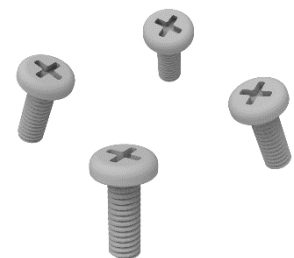

Before using this Maxspect™ RSX LED Lighting System please read these operating instructions carefully. Take special care to follow the safety suggestions listed below.

Afterwards keep this manual handy for future reference.

Before using the Maxspect™ RSX LED Lighting System

1. Remove any plastic bags and packaging material protecting the fixture.
2. Never look directly at the LED bulbs when you switch on the system. Incorrect use of this apparatus will increase eye hazard.

On Safety

1. **Power Source** – Do not defeat the safety purpose of the polarized or grounding-type plug. A polarized plug has two blades with one wider than the other. A grounding-type plug has two blades and a third grounding prong. The wide blade or the third prong are provided for your safety. If the plug does not fit into your outlet, consult an electrician for replacement of the obsolete outlet.
2. **Power Cord Protection** – The power supply cords should be routed so that they are not likely to be walked on or pinched by items placed upon or against them. Never take hold of the plug or cord if your hand is wet, and always grasp the plug body when connecting or disconnecting it.
3. **Installation** – Install indoor only, and use the attachments, mounting frames, hanging kit and accessories provided and specified by the manufacturer.

On Operation

1. **Operation** – Always follow the operation instructions set forth in this manual when using this Maxspect™ RSX LED Lighting System.
2. **Heat** – The apparatus should be situated away from heat sources such as radiators, and do not expose to excessive heat such as sunshine, fire or the like.
3. **Moisture** – To reduce the risk of fire or electric shock, do not expose this apparatus to rain, moisture, dripping or splashing.
4. **Ventilation** – The apparatus should be situated so that its location or position does not interfere with its proper ventilation.
5. **Magnetism** – The apparatus should be situated away from equipment or devices that generate strong magnetism.
6. **Cleaning** – Clean only with dry cloth.

Mounting the RSX LED Lighting System

Before connecting the RSX to the power supply, first mount the system by using the provided stand.

1. Tank-top mounting.

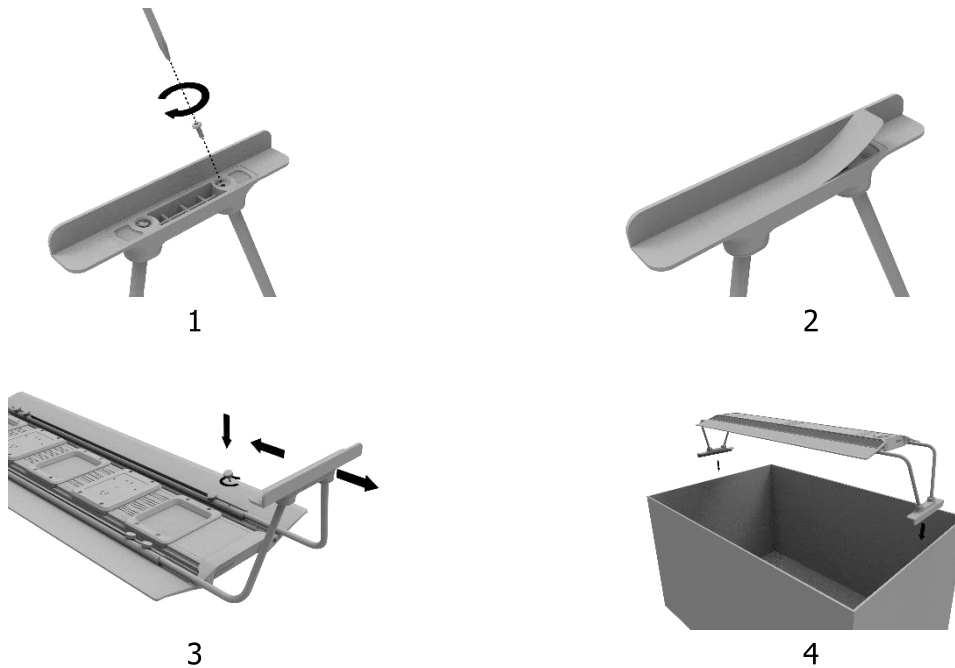

2. Pendant Mounting (hanging Kits sold separately).

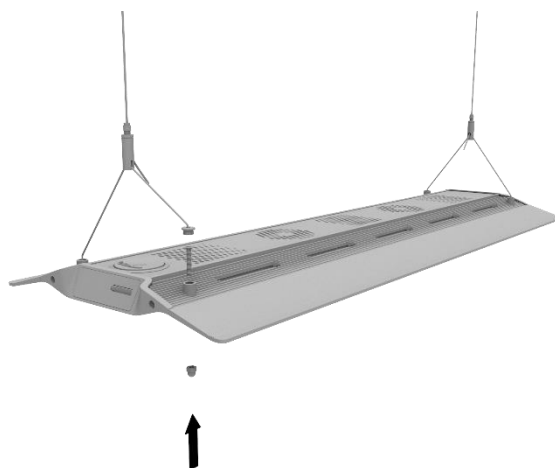

Operating Instructions

English

Built-in Controller

The RSX can be controlled directly with the built-in controller. The built-in controller integrated in the RSX features an OLED monitor and a control dial, from which user can setup all the functions for the fixture.



Standard or Master/Slave Mode

Suppose there are 2 or more units of RSX fixtures, user can connect them together through the Master/Slave mode to control them simultaneously - all Slave fixtures will follow the settings programmed on the Master fixture, saving time and effort on setting up multiple fixtures.

Control with iOS or Android Devices (Optional)

The RSX can also be wirelessly connected to an ICV6 controller (sold separately), which allows the Recuve fixtures to be controlled by iOS or Android devices through the Syna-G System.



Basic Operations

English

Follow the instructions below to operate and program the RSX LED fixture.

The RSX turns on automatically when power is connected, and turns off when power is cut.

When power is resumed, the RSX will restore to the previous saved setting automatically, whether it was last set at Manual or Automatic Mode, and the intensity level of all the LED channels.

The fan on the RSX fixture is temperature controlled.

The RSX has a built-in temperature control system. The fan will be automatically engaged when the temperature is above 55°C/131°F, and disengage when it is below 45°C/113°F.

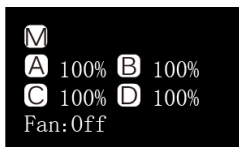

Below 45°C/113°F

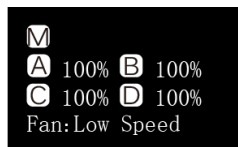

Above 55°C/131°F

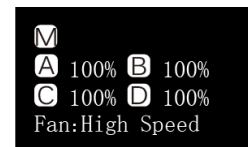

Above 65°C/149°F

If the fan fails, the system may overheat and the system will enter fail-safe mode when the temperature is above 80°C/176°F, turning off all channels. The system will exit fail-safe mode and resume normal operation when the temperature drops below 70°C/158°F.

Switching between Auto and Manual Mode

The RSX has two modes of operations: Auto and Manual Mode. User can switch between the two modes with the control dial on the fixture.



- Press and hold the control dial for 3 seconds to switch to another mode.

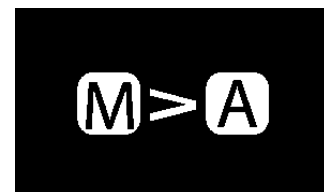

Operating Instructions

English

Manual Mode

- Press the control dial to enter the setting.
- Press the control dial again to switch between the channels.
- Rotate the control dial to set the brightness for each LED channel.
- Press and hold the control dial for 3s to save the setting and exit the page.



Automatic Mode

- Press the control dial to enter the setting.
- Rotate the control dial to switch between the settings.
- Press and hold the control dial for 3s to save the setting and exit the page.

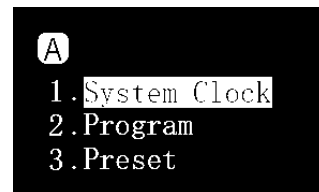
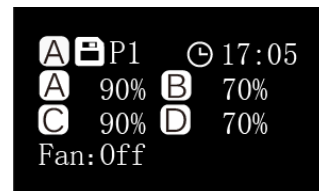

Within Automatic Mode, there are 3 settings for user to select:

System Clock: A clock set to be matched with users' local time.

Program: Program the photoperiod to set specific brightness for each LED channel during different time of the day.

Preset: 4 preset settings are available for user to choose from. (Refer to p.16)

P1: SPS dominated tank.

P2: SPS/LPS mixed tank.

P3: Soft Coral/LPS mixed tank.

P4: SPS dominated tank with a different dawn/dusk time with moon light.

Setting the clock

- Press the control dial to enter the setting page and then select "System Clock".
- Press the control dial to switch between hour and minute.
- Rotate the control dial to set the time.
- Press and hold the control dial for 3s to save the setting and exit the page.

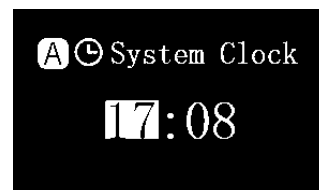
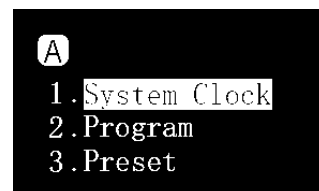

Understanding Time Points

English

There are a total of 24 Time Points. You can program different luminous output intensity at each Time Point to control the photoperiod and brightness of the system.

Take Preset P1 as an example, it is a setting for SPS dominated tank. The photoperiod starts at 08:00 where the system increases light gradually, peaks at 10:00 and lasts 10hrs to 20:00 before the system gradually decreases light until it is turned off at 22:00, with moon light turns on.

	TP01	TP02	TP03	TP04	TP05	TP06	TP07	TP08
	08:00	09:00	10:00	20:00	20:30	21:00	21:30	22:00
Channel A	0%	40%	90%	90%	70%	50%	25%	0%
Channel B	0%	20%	70%	70%	30%	15%	10%	0%
Channel C	1%	20%	70%	70%	30%	15%	10%	1%
Channel D	0%	20%	90%	90%	30%	15%	10%	0%

The following diagram illustrates how the 4 LED channels would behave once the above Time Points have been programmed.

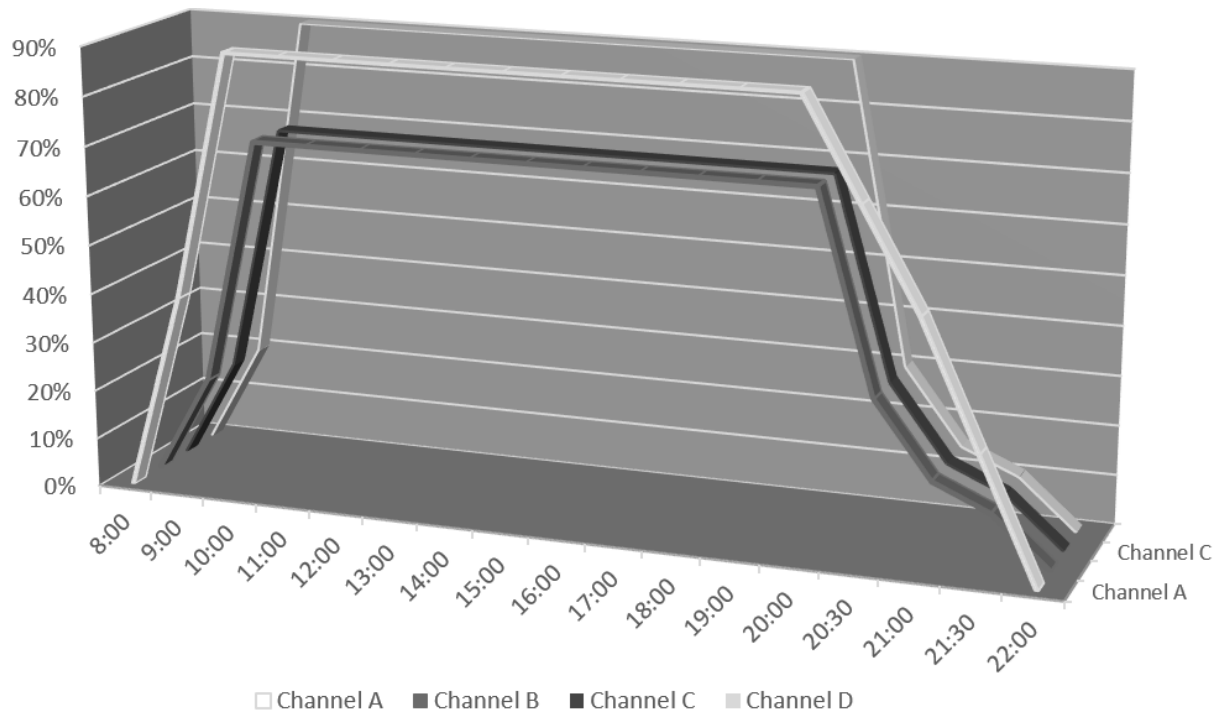

Operating Instructions

English

Programming Photoperiod

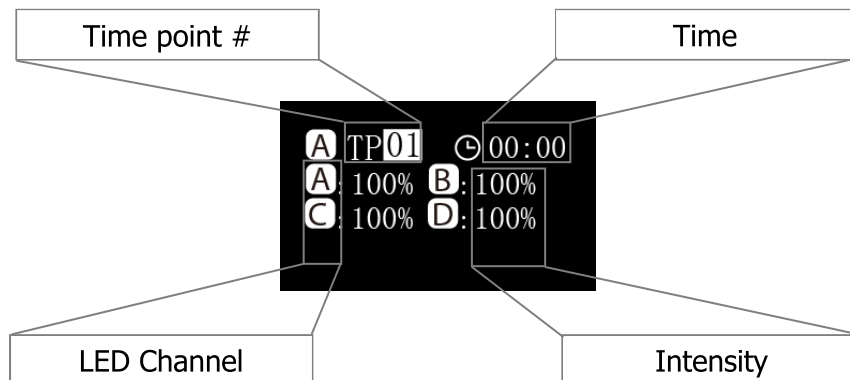

Modify

- Press the control dial to switch between the parameters.
- Rotate the control dial to set the parameter.
- Press and hold the control dial for 3s to turn to the next page.

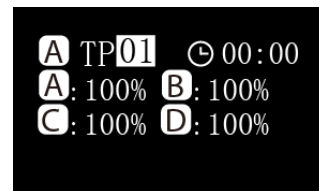

Apply

- Rotate the control dial to select "Apply".
- Press the control dial to save the setting.
- Press and hold the control dial for 3s to return to the main menu.



Preview

- Rotate the control dial to select "Preview".
 - Press the control dial to runs the program in preview mode, where the entire photoperiod is demonstrated in 3 minutes.
 - Press and hold the control dial for 3s to return to the main menu.
- Rotate the control dial to select "Modify".
 - Press the control dial to readjust the parameters, see "Modify" above.



Selecting Preset

English

- Rotate the control dial to switch between the presets.
- Press the control dial to turn to the next page.

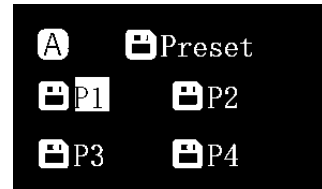

Apply

- Rotate the control dial to select "Apply".
- Press the control dial to save the setting.



Preview

- Rotate the control dial to select "Preview".
- Press the control dial to runs the program in preview mode, where the entire preset is demonstrated in 3 minutes.
- Press and hold the control dial for 3s to return to the main menu.



- Rotate the control dial to select "Exit".
- Press the control dial to go back to the main menu.



Maintenance Instructions

English

System Setup

System Setup features a set of functions allowing user to do perform maintenance on the fixture.

To enter the System Setup page, first turn off the fixture, then press and hold the control dial while turning the fixture back on. Keep on holding the control dial until the system setup page is shown on OLED monitor.

There are 7 functions in the System Setup screen.

1. Firmware
2. Restore
3. Reset
4. Test Mode
5. Model Number
6. Standard or Master/Slave mode
7. Exit

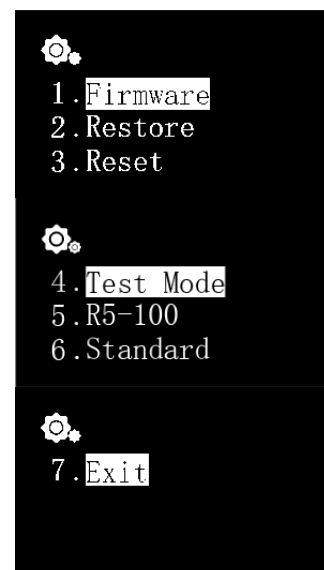

1. Firmware

This function allows the user to update the firmware.

- Rotate the control dial to select "Firmware".
- Press the control dial to begin the firmware update.
- When there is no TF (micro SD) card or invalid firmware in the TF card, "NO TF Card" or "Wrong File" will be shown.
- Otherwise the firmware update progress will be shown.
- Once the firmware has been updated successfully, the fixture will restart automatically and the new firmware version number will be shown.

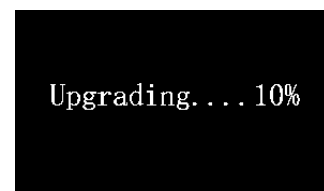

2. Restore

This function allows the user to restore the firmware to its original factory version. After finish restoring the firmware, the fixture will restart automatically and the firmware version number will be shown.

- Rotate the control dial to select "Restore".
- Press the control dial to restore the firmware.



3. Reset

This function allows the user to reset the fixture back to its factory settings. After finish resetting the fixture, it'll restart automatically.

- Rotate the control dial to select "Reset".
- Press the control dial to factory reset the fixture.



4. Test Mode

This function allows the user to put the fixture in the test mode, which would help our customer service representative to diagnose the fixture. **This should only be done by the users when told by authorized dealer or customer representative to perform certain test on the fixture.**

5. Model Number

This function will display the model number of the fixture, which also double serves as the ID name when the RSX is connected to an iOS or Android device through the Syna-G system. **Under normal circumstances this value should not be changed.**

Maintenance Instructions

English

6. Standard or Master/Slave Mode

This function allows the user to choose between the Standard stand-alone operation mode, or Master/Slave mode where multiple units of RSX fixtures can be connected together.

Once connected, all Slave fixtures will follow the settings programmed on the Master fixture, saving time and effort on setting up multiple fixtures.

The default value is "Standard" meaning the fixture is running in stand-alone operation mode.

When a RSX is set as Master Unit, it will need to assign a channel from 01 to 10. All connecting Slave Units must be also assigned to the same channel.

In case where multiple groups of Master/Slave coexist in a proximity, each Master Unit must assign a different channel to avoid interference with another group.

- Rotate the control dial to select "Standard".
- Press the control dial to enter the setting page.
- Rotate the control dial to assign it as a "Master" or "Slave" unit.
- After selecting Master/Slave unit, press the control dial to assign a channel.
- Press and hold the control dial for 3s to save the setting.

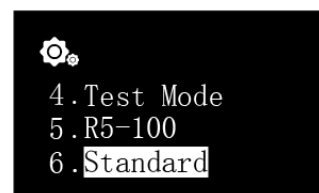

7. Exit

- Press "Exit" to restart the fixture.

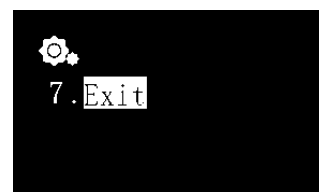

Maintenance of the fixture

User must periodically perform maintenance on the fixture, including but not limited to the following steps:

- Using a damp cloth to clean the acrylic lens to make sure it's not covered by salt creep or other dirt and debris. Uncleaned lens will severely affect the luminous output of the fixture, so for best performance you should clean the lens once a week.
- Clean the dust and debris trapped in the fan units. Regularly and properly cleaned fans will last much longer than those that aren't. Fan units are wear-and-tear parts and must be replaced every 24-36 months depends on the frequency of maintenance performed on them.
- Clean / remove any salt creep or dirt and debris that had been builtup or collected on the aluminum body of the fixture, as they may affect the dissipation of heat from the fixture.

Note: Failure to perform the above mentioned maintenance on the fixture may cause unnecessary damage to your fixture and may void your warranty!

Specifications

For latest specifications on LED layout, types and color spectrum, please visit our website at: www.maxspect.com



Limited Warranty

English

Maxspect (HongKong) Limited warrants all Maxspect™ RSX LED Lighting System products against defects in workmanship for a period of 12-months from the date of purchase. If a defect exists during the warranty period, Maxspect (HongKong) Limited at its option will either repair (using new or remanufactured parts) or replace (with a new or remanufactured unit) the product at no charge.

THE WARRANTY WILL NOT APPLY TO THE PRODUCT IF IT HAS BEEN DAMAGED BY MISUSE, ALTERATION, ACCIDENT, IMPROPER HANDLING OR OPERATION, OR IF UNAUTHORIZED REPAIRS ARE ATTEMPTED OR MADE. SOME EXAMPLES OF DAMAGES NOT COVERED BY WARRANTY INCLUDE, BUT ARE NOT LIMITED TO, USING AFTER-MARKET LED BULBS AND MODIFICATION OF THE CIRCUITRY, WHICH ARE PRESUMED TO BE DAMAGES RESULTING FROM MISUSE OR ABUSE.

DISCLAIMER OF CONSEQUENTIAL AND INCIDENTAL DAMAGES:

You and any other user of Maxspect (HongKong) Limited products shall not be entitled to any consequential or incidental damages, including without limitation, loss of use of the unit, inconvenience, damage to personal property, phone calls, lost income or earnings. This warranty gives you specific legal rights and you may also have other rights, which vary from state to state.

MAXSPECT LTD. MAKES NO WARRANTY OR REPRESENTATION, EITHER EXPRESS OR IMPLIED, WITH RESPECT TO THE PRODUCT'S QUALITY, PERFORMANCE, MERCHANTABILITY, OR FITNESS FOR A PARTICULAR PURPOSE. AS A RESULT, THIS PRODUCT, IS SOLD "AS IS," AND YOU THE PURCHASER ASSUME THE ENTIRE RISK AS TO ITS QUALITY AND PERFORMANCE.

IN NO EVENT WILL MAXSPECT LTD BE LIABLE FOR DIRECT, INDIRECT, SPECIAL, INCIDENTAL, OR CONSEQUENTIAL DAMAGES RESULTING FROM ANY DEFECT IN THE PRODUCT OR ITS DOCUMENTATION.

The warranty, disclaimer, and remedies set forth above are exclusive and replace all others, oral or written, expressed or implied. At no time will any Maxspect (HongKong) Limited dealers, agents, or employees be authorized to make any modifications, extension, or addition to this warranty.

Some states do not allow the exclusion or limitation of implied warranties or liability for incidental or consequential damages, so the above limitation or exclusion may not apply to you.

English

Preset 1

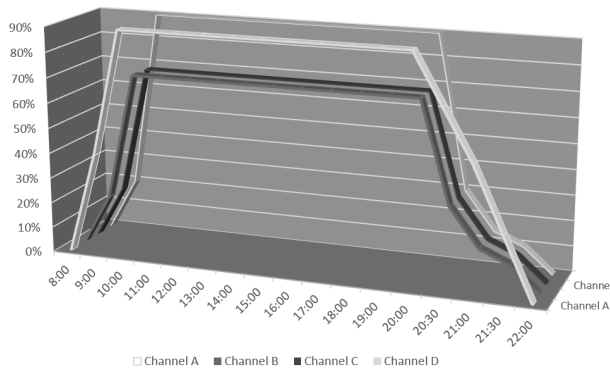

Preset 2

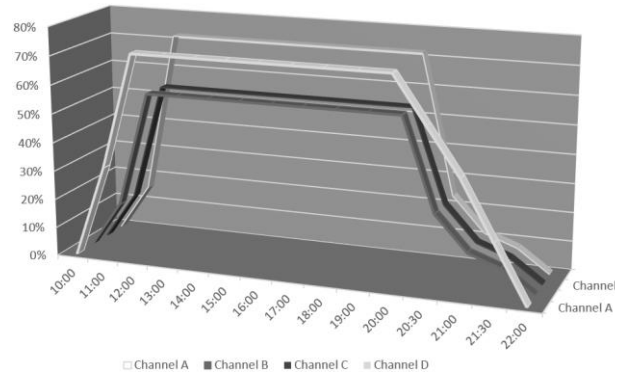

Preset 3

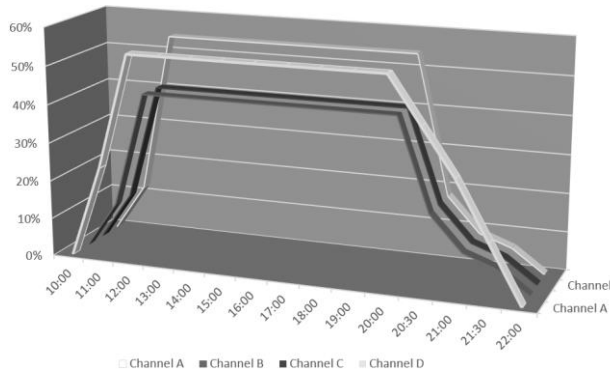

Preset 4

